

Sechskantsschraube

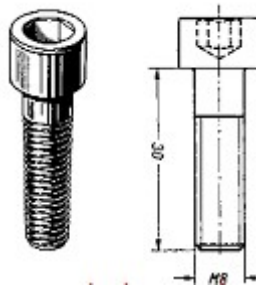

Innensechskantschraube
Inbusschraube

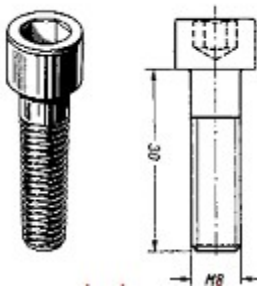
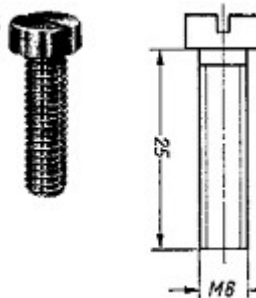
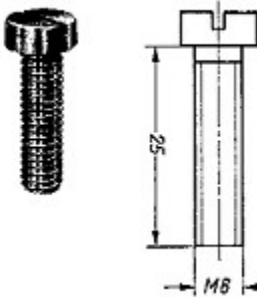

Zylinderschraube

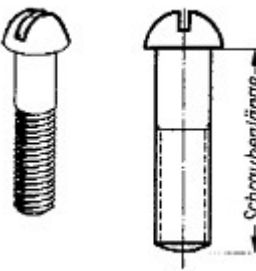
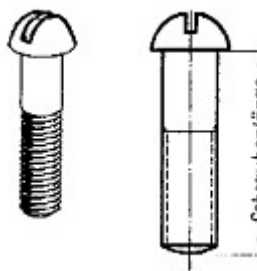

Halbrundschraube

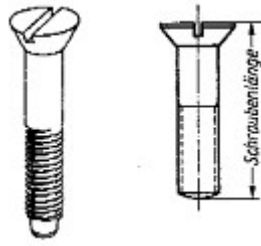
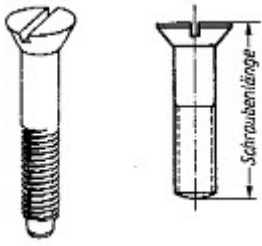

Senkkopfschraube



Rändelschraube

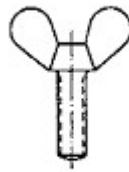
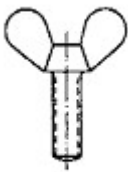

Flügelschraube



Linsenkopfschraube

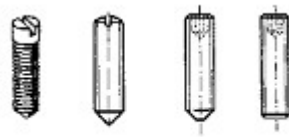
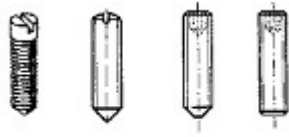

Gewindestifte

—

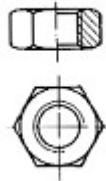
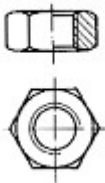

Sechskantmutter

—

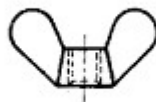
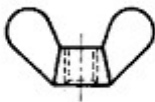

Flügelmutter

—

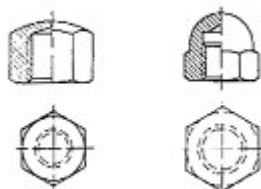
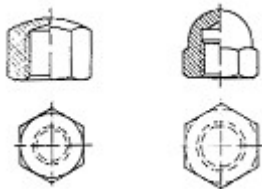

Hutmutter

—

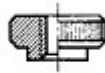
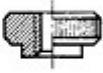

Rändelmutter

—



Federring

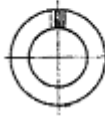
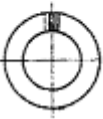

—



Zahnscheibe

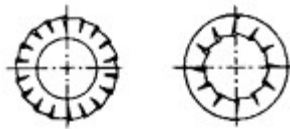
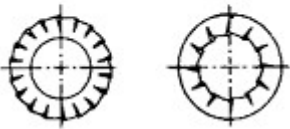

—

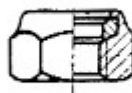

selbstsichernde Mutter

—

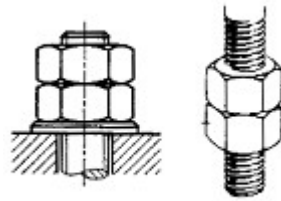
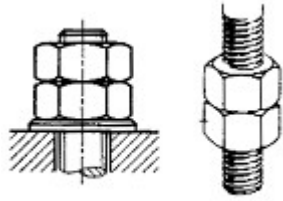

Doppelmutter
Gegenmutter
Kontermutter



Aussensicherungsring
Aussenseegerring

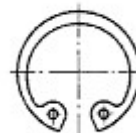

Innensicherungsring
Innensegerring



Sprengerring

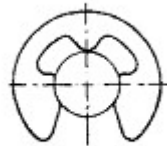
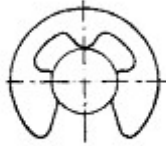

Sicherungsscheibe

—



Nasenkeil

—



Flachkeil

—



Passfeder rundstirnig

—



Passfeder geradestirnig

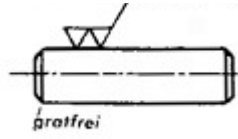
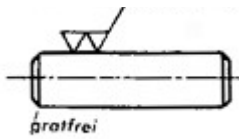

Zylinderstift

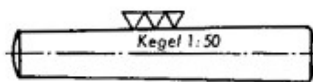
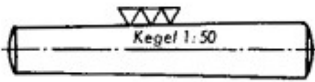

Kegelstift
konischer Stift



Spannstift

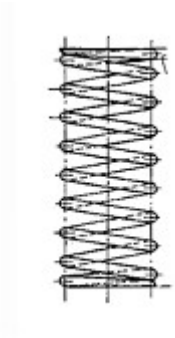
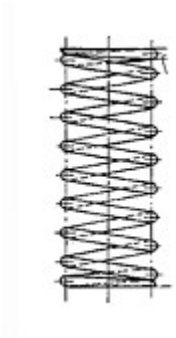

Druckfeder



Spiralfeder

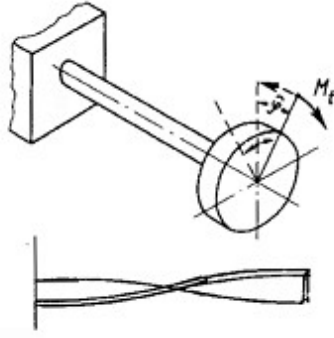
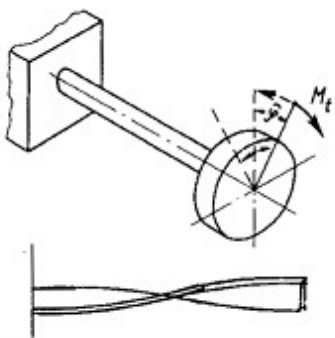

Torsionsfeder
Verdrehfeder

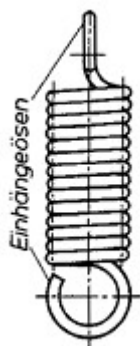
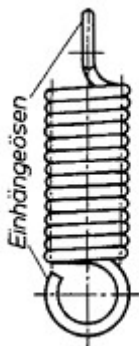

Zugfeder



Innensechskantschlüssel
Inbusschlüssel

—



Doppelmaulschlüssel

—



Rollgabelschlüssel

—

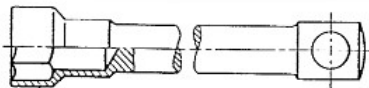
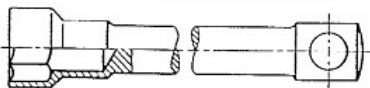

Steckschlüssel

—



Hakenschlüssel

—

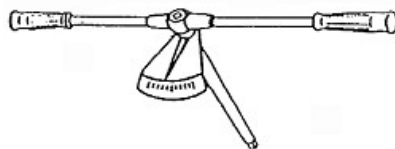
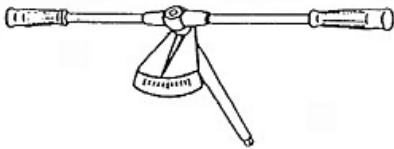

Drehmomentschlüssel

—



zylindrischer Durchschläger

—



konischer Durchschläger

—

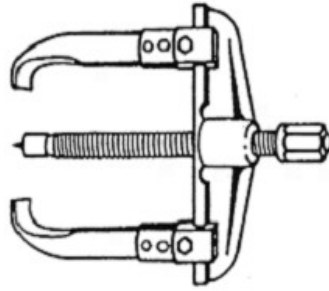
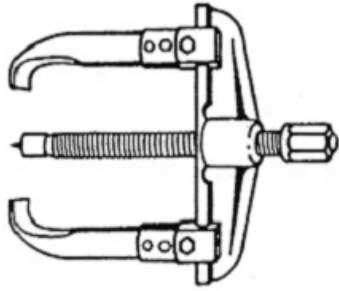

Abziehvorrichtung
für Kugellager

—



Buchbinderschnitzer

—

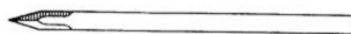

Klinge zu Buchbinderschnitzer

—



Buchbinderschnitzer
mit fester Klinge

—

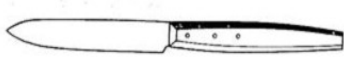

Buchbindermesser lang

—



Buchbindermesser kurz

—



Japanmesser gross

—



Japanmesser klein

—

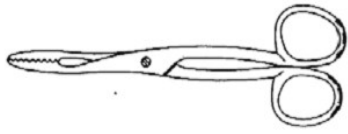

Scherenpinzette

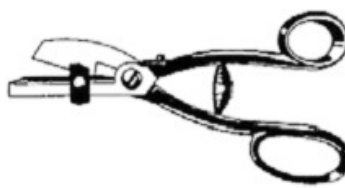
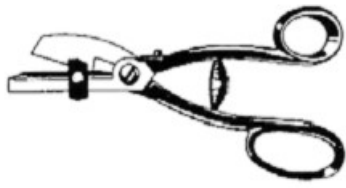

Registerschere



Papierschere

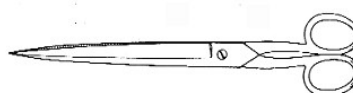
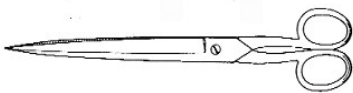

Papierschere lang

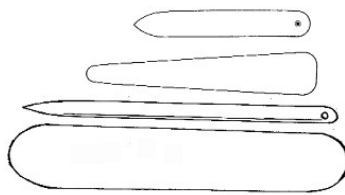
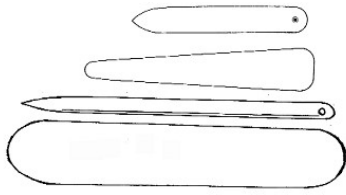

Falzbeine
aus Knochen
Metall
Kunststoff (PTFE, Teflon)

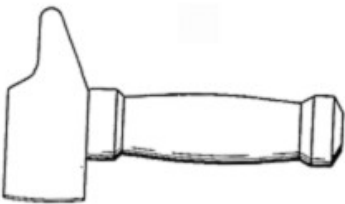
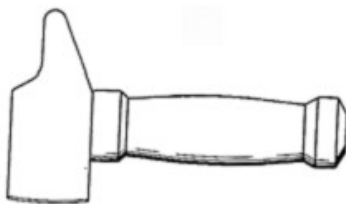

Abpresshammer

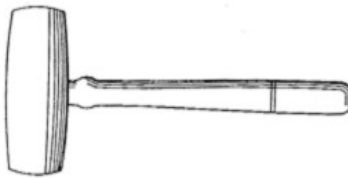

Holzhammer

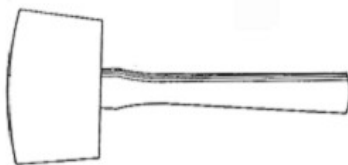
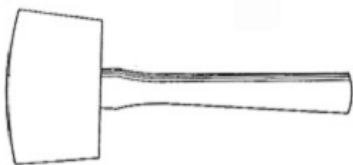

Holzhammer

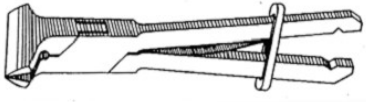

Bundzange
Bündezange

—

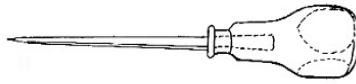
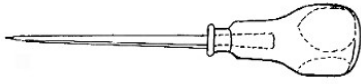

Ahle

—

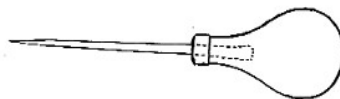
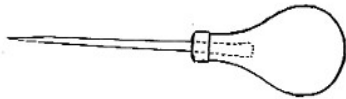

Ahle

—

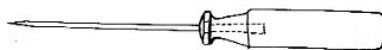

Ahle

—

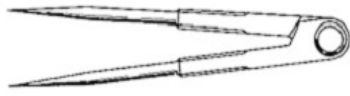

Stechezirkel

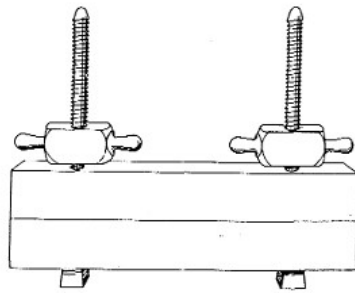
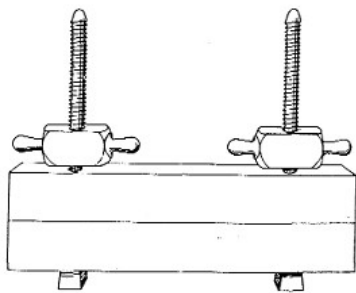

Handpresse mit
Metallspindeln

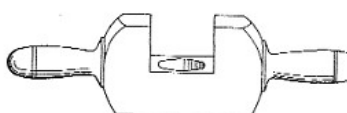
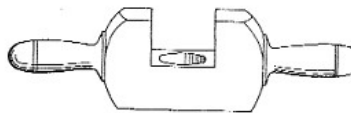

Pressbengel

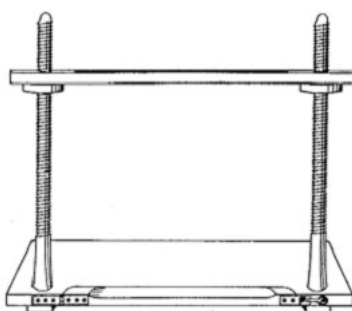
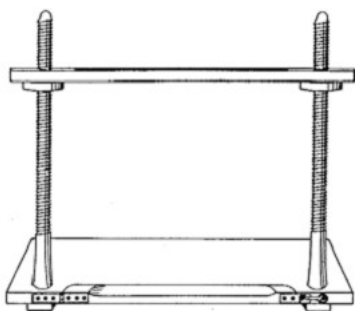

Heftlade



Hefstift

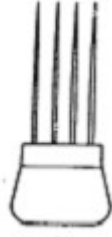

Hefbandhalter



Hefhaken

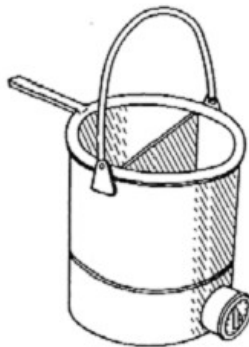
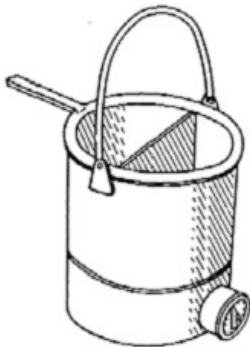

Warmleimkessel mit
Wasserbad

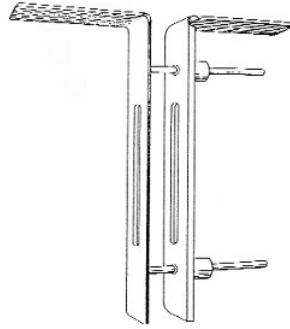
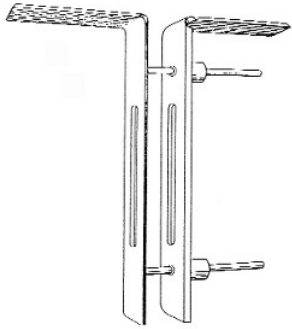

Deckenmachwinkel



Aufschablech
Schablech



Sprengbürste

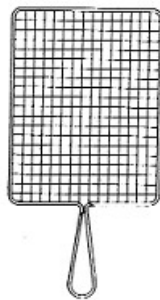

Sprenggitter

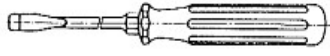
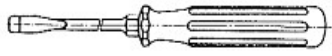

Schraubendreher

—



Doppelringschlüssel

—

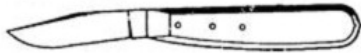

Buchbindermesser kurz

—

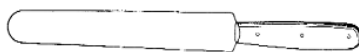

Papiermesser
Vergoldemesser

—

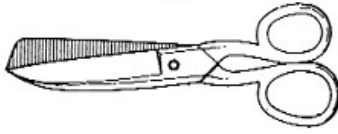
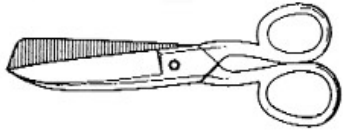

Kartonschere



Eisenhammer
Schlosserhammer

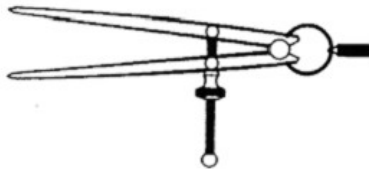
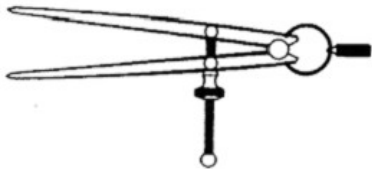

Stechzirkel

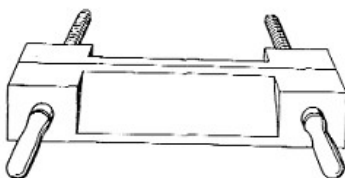
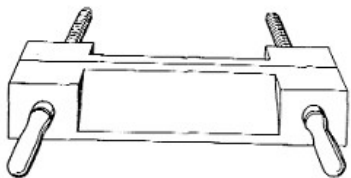

Vergoldeklotzpresse

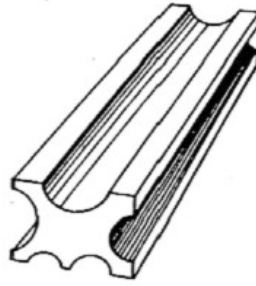
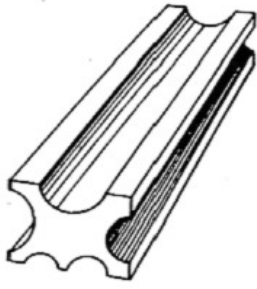

Rückenholz
(mit 5 Kehlen)



Gerär Schärfmesser



Pariser Schärfmesser
